

Varenummer: 40550500882425  
 Beskrivelse: Tandhjulsgeaer S501F-8,8-P71B5

## Mål

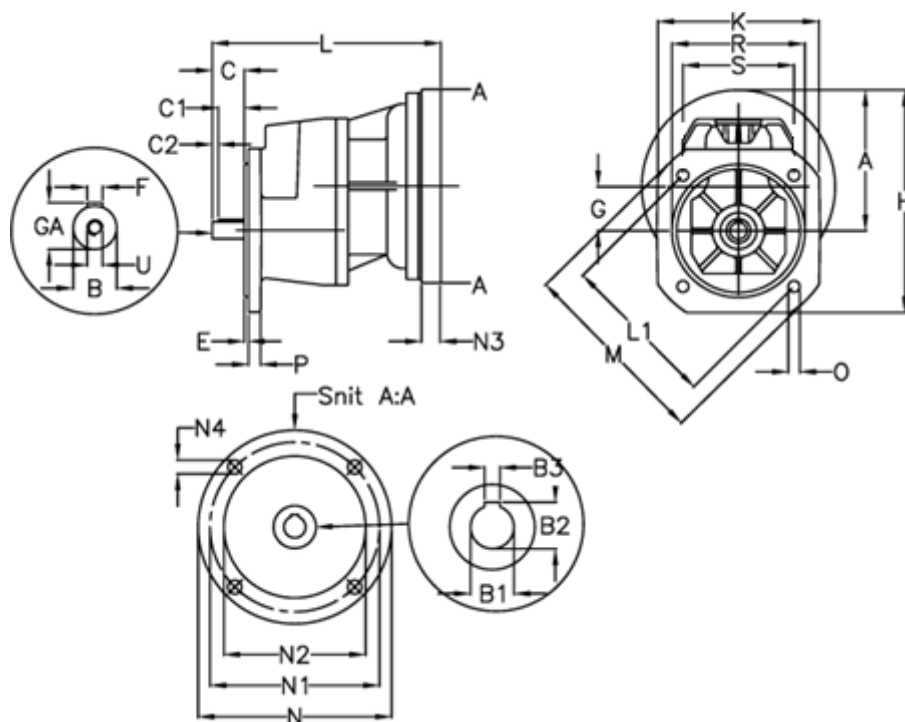

A = 196.5	E = 4.0	M = 300.0	R = 230
B = 38	F = 10x8x60	N = 160	S = 185
B1 = 14	G = 73.5	N1 = 130	U = M12
B2 = 16.3	GA = 41.0	N2 = 110	
B3 = 5	H = 326.5	N3 = -	
C = 80	K = 260	N4 = M8x16	
C1 = 60	L = 314	O = 14.0	
C2 = 10	L1 = 265.0	P = 15	